

\* = Conical form tapering downward.  
 Untoleranced dimensions per DIN 16901-140

LID

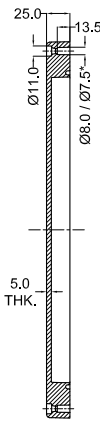

SECTION C-C

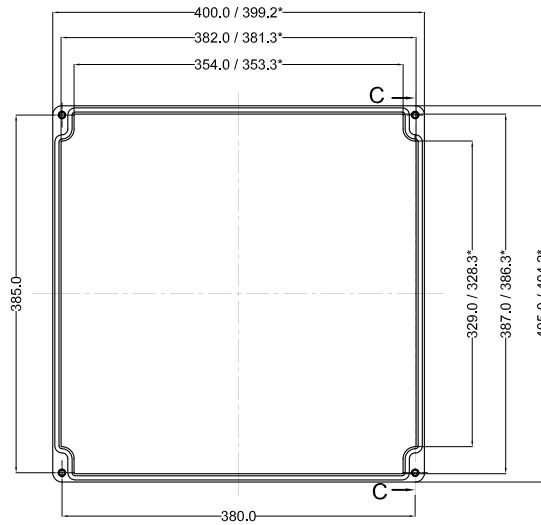
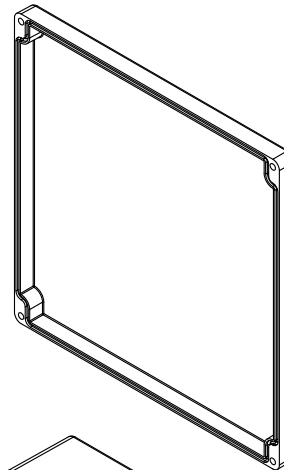

BASE

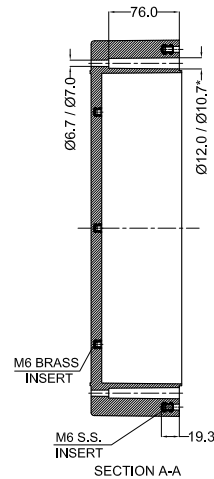
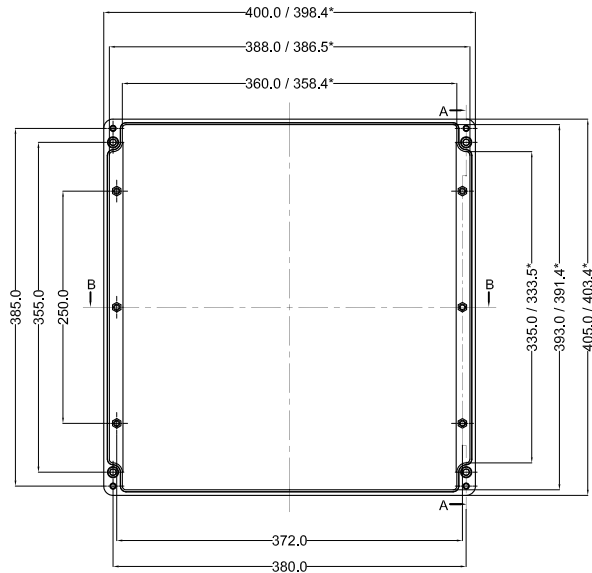

SECTION A-A

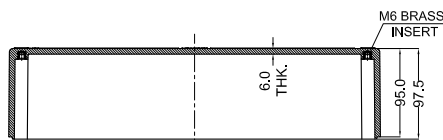
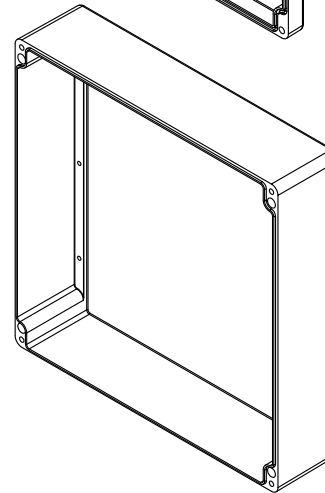

SECTION B-B

| OPTIONAL ACCESSORIES    |      |             |
|-------------------------|------|-------------|
| PART NAME               | QTY. | AVILABILITY |
| MOUNTING PLATE          | 1    | Y           |
| EXTERNAL HINGE          | 1    | Y           |
| INTERNAL HINGE          | -    | N           |
| MOUNTING BRACKETS       | 4    | Y           |
| NEOPRENE/SILICON GASKET | 1    | Y           |
| DIN RAIL TS15           | -    | N           |
| DIN RAIL TS35           | 1    | Y           |

| NO.       | REV.NO.                 | DESCRIPTION | DATE                    | DRAWN     | CHECKED              |
|-----------|-------------------------|-------------|-------------------------|-----------|----------------------|
| -         | -                       | -           | -                       | -         | -                    |
| QUANTITY  | MATERIAL :-             | MACH.NAME   | DATE                    | SIGN      | NAME                 |
| -         | <b>GRP</b>              | -           | 03/01/14                |           | <b>RRPL DESIGN</b>   |
|           |                         |             | 03/01/14                |           | <b>MANOJ DRAWN</b>   |
|           |                         |             | 03/01/14                |           | <b>PAVAN CHECKED</b> |
|           |                         |             |                         |           | <b>M.S. APPROVED</b> |
| TOLERANCE | WEIGHT :                | FINISH :    | TITLE :-                |           |                      |
| ±0.2      | -                       | -           | GRP JUNCTION BOX        |           |                      |
| ±0.2      |                         |             | 405 x 400 x 120         |           |                      |
| ±1.0°     | ALL DIMENSION ARE IN MM |             | Raychem RPG (P) Limited |           |                      |
|           | GRJ 16                  |             | SCALE                   | PARTNO. . |                      |
|           |                         |             | REV                     |           | DRG. NO.             |
|           |                         |             | 00                      |           | GJB-405400120-0      |

PROPERTY OF RaychemRPG (P) LTD.  
 ALL RIGHTS RESERVED AND/OR PHOTOCOPYING THIS DOCUMENT  
 TO A PERSON WITHOUT RaychemRPG (P)LTD. WRITTEN AUTHORIZATION IS PROHIBITED

| Sr.No. | Drawing no.        | RM Grade | Finish        |
|--------|--------------------|----------|---------------|
| 2      | GJB-405400120-B-02 | GRP-30   | BLACK RAL9011 |
| 1      | GJB-405400120-B-01 | GRP-23   | GREY RAL7000  |