

LID

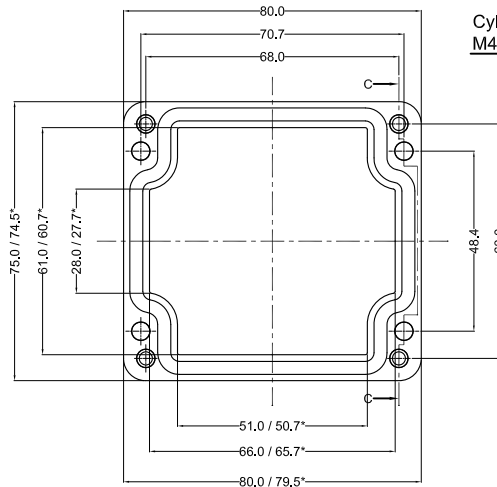

Cylinder Screw  
M4 x 24/7 similar to DIN 84

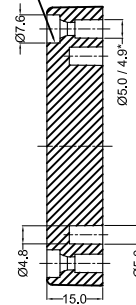

SECTION C-C

\* = Conical form tapering downward.  
Untoleranced dimensions per DIN 16901-140

OPTIONAL ACCESSORIES		
PART NAME	QTY.	AVAILABILITY
MOUNTING PLATE	1	Y
EXTERNAL HINGE	-	N
INTERNAL HINGE	-	N
MOUNTING BRACKETS	4	Y
NEOPRENE/SILICON GASKET	1	Y
DIN RAIL TS15	1	Y
DIN RAIL TS35	-	N

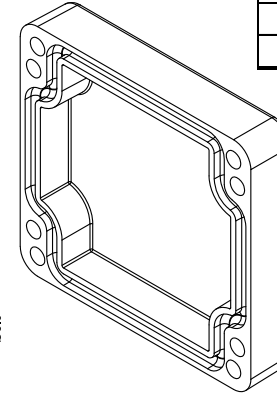

BASE

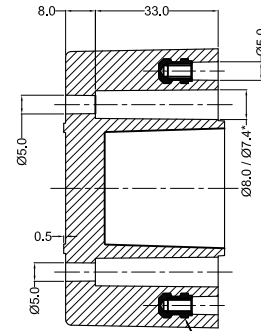
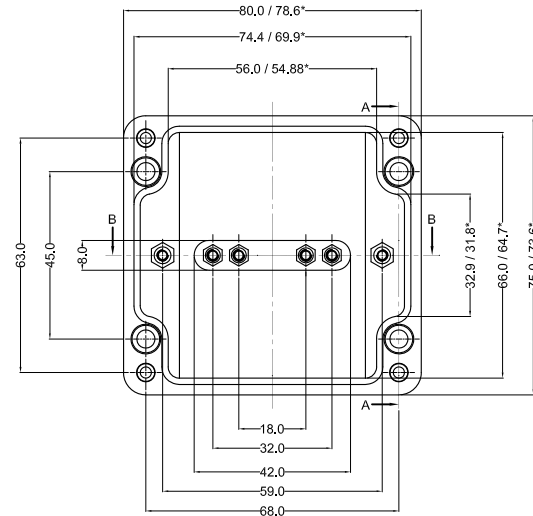

SECTION A-A M4 S.S. INSERT

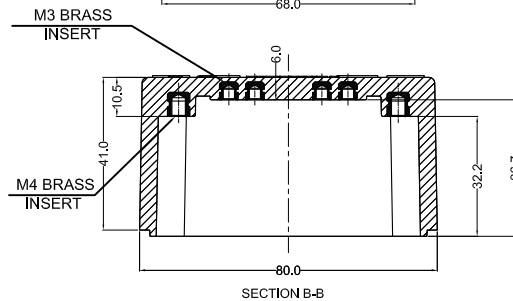
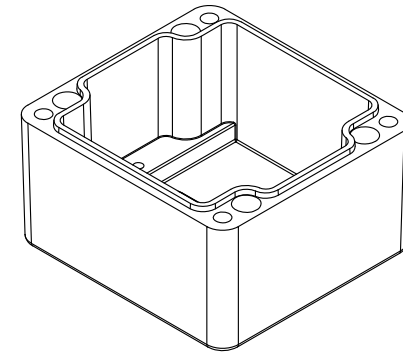

SECTION B-B

3	GJB-758055-B-03	GRP-30	BLACK RAL9011	02
2	GJB-758055-B-02	GRP-30	BLACK RAL9011	01
1	GJB-758055-B-01	GRP-23	GREY RAL7000	
Sr.No.	Drawing no.	RM Grade	Finish	VERSION

NO.	REV.NO.	DESCRIPTION	DATE	DRAWN	CHECKED
-	-	-	-	-	-
QUANTITY	MATERIAL :-	MACH.NAME	DATE	SIGN	NAME
-	<b>GRP</b>	-	03/01/14		<b>RRPL DESIGN</b>
			03/01/14		<b>MANOJ DRAWN</b>
			03/01/14		<b>PAVAN CHECKED</b>
					<b>M.S. APPROVED</b>
WEIGHT:	FINISH:	TITLE :-	SCALE PARTNO. .		
-	-	GRP JUNCTION BOX 75 x 80 x 55	Raychem RPG (P) Limited		
TOLERANCE		Ceat Mahal Annexe, Dr. Annie Besant Road , Worli , Mumbai 400030 Web : www.raychemrpg.com			
±0.2	HOLE	DRG. NO.			
±0.2	HOLES	REV			
±1.0°	ANGLES	GJB-758055-0			

PROPERTY OF RaychemRPG (P) LTD.  
ALL RIGHTS RESERVED AND/OR PHOTOCOPYING THIS DOCUMENT  
TO A PERSON WITHOUT RaychemRPG (P) LTD. WRITTEN AUTHORIZATION IS PROHIBITED