

* = Conical form tapering downward.
 Untoleranced dimensions per GTA 13/5 DIN 1688

LID

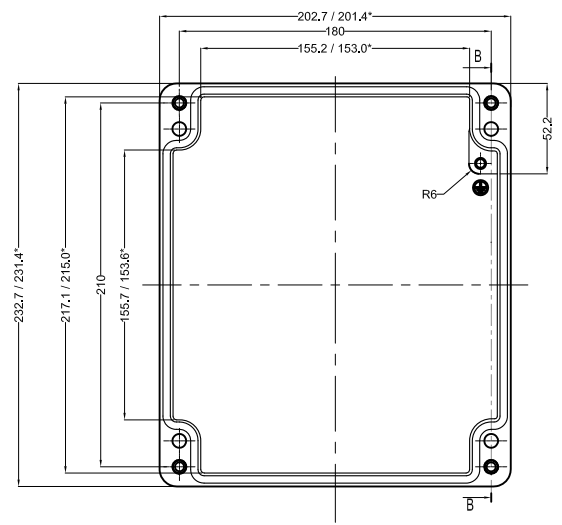

Cylinder Screw
 M6 x 25/10 similar to DIN 84

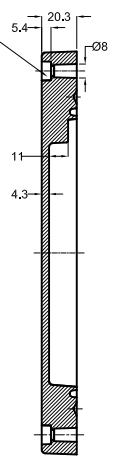

SECTION B-B

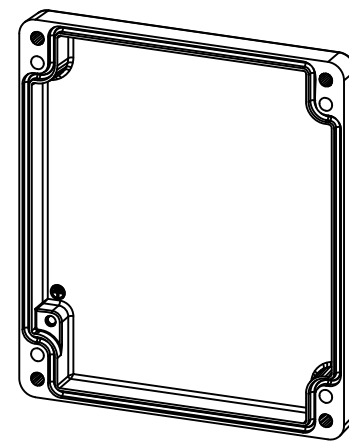

OPTIONAL ACCESSORIES		
PART NAME	QTY.	AVAILABILITY
MOUNTING PLATE	1	Y
EXTERNAL HINGE	2	Y
INTERNAL HINGE	2	Y
MOUNTING BRACKETS	4	Y
NEOPRENE/SILICON GASKET	1	Y
DIN RAIL TS15	-	N
DIN RAIL TS35	1	Y

BASE

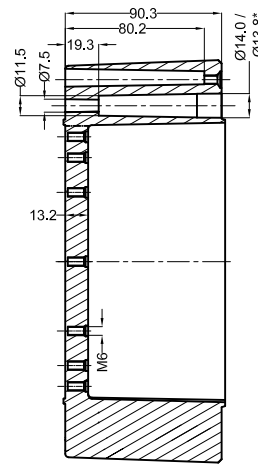
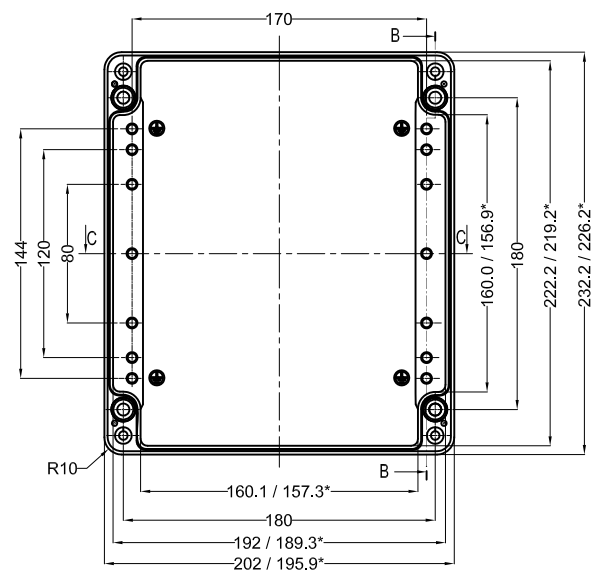

SECTION B-B

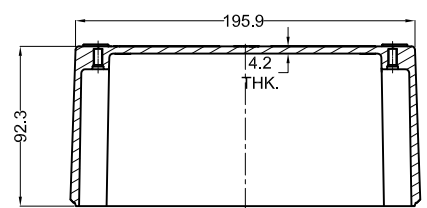
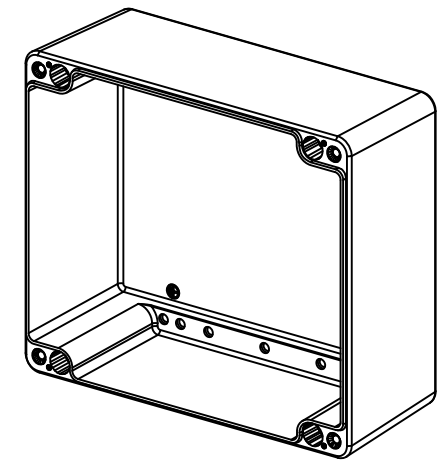

SECTION C-C

QUANTITY 1	MATERIAL :- ALs112 (Din230)	MACH.NAME -	DATE 18/06/12	SIGN MANOJ	NAME DRAWN
	WEIGHT: - FINISH: NATURAL	TITLE :- JUNCTION BOX 200 x 230 x 110	18/06/12	PAVAN	CHECKED
				S. D.	APPROVED
TOLERANCE		Raychem RPG (P) Limited	SCALE	PARTNO. 0	
±0.2 DIMENSIONS		Ceat Mahal Annexe, Dr. Annie Besant Road , Worli , Mumbai 400030 Web : www.raychemrpg.com	REV	DRG. NO.	
±0.2 HOLES	ALL DIMENSION ARE IN MM		0	AJB-200230110	
±1.0° ANGLES	RJ 19				

PROPERTY OF RaychemRPG (P) LTD.
 ALL RIGHTS RESERVED AND/OR PHOTOCOPYING THIS DOCUMENT
 TO A PERSON WITHOUT RaychemRPG (P)LTD. WRITTEN AUTHORIZATION IS PROHIBITED