

GENERAL SPECIFICATION AND AREA CLASSIFICATION:

1. MATERIAL COMPOSITION - AISI 12
2. DEGREE OF PROTECTION IP66 AS PER IEC 60529 : 1989 +A1 : 2000
3. SERVICE TEMPERATURE RANGE : - 50 °C to +135 °C
4. ALL DIMENSIONS ARE IN mm. UNLESS STATED OTHERWISE.
5. SURFACE WILL PLAIN FINISH OR POWDER COATED.(RAL-7001)
6. THE JUNCTION BOX WILL BE MARKED WITH



8. TRADE MARK **NOT TO BE REVISED WITHOUT NOTIFICATION TO THE ExCB/NOTIFIED BODY**

LID

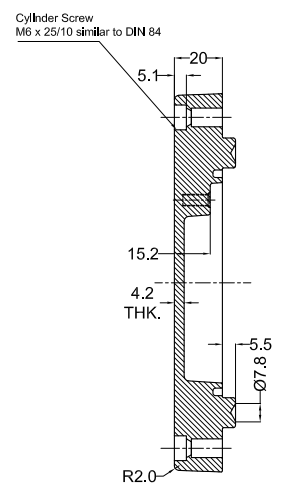
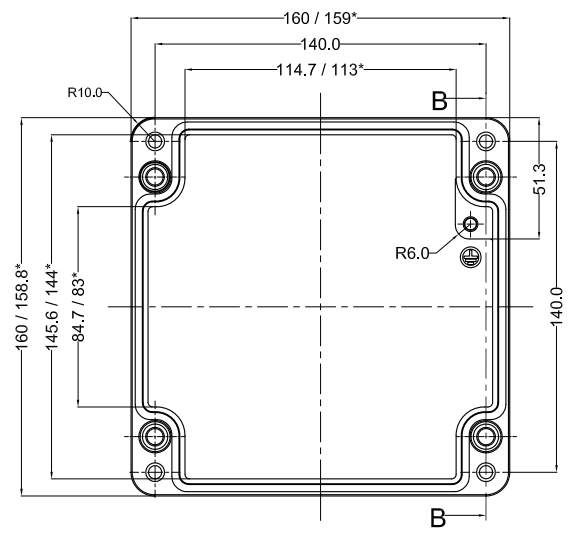

SECTION B-B

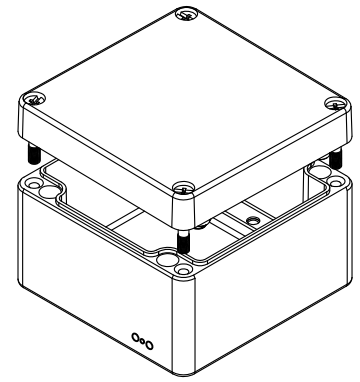
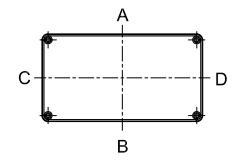

BASE

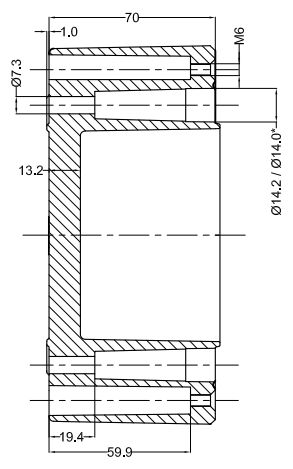
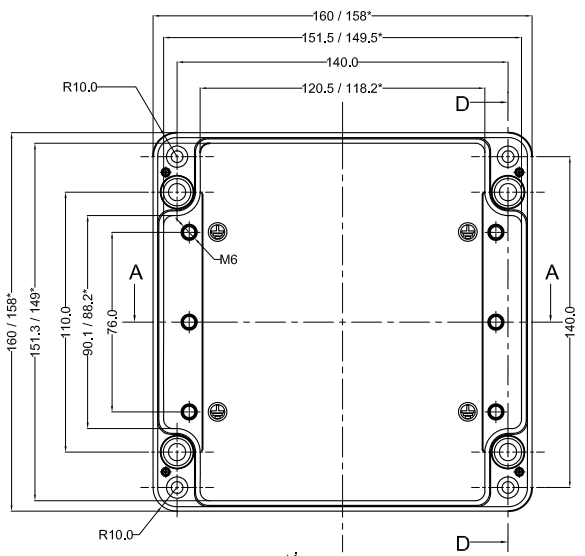

SECTION D-D

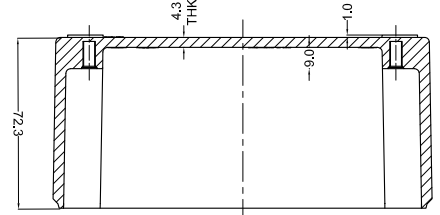

SECTION A-A

Opening Detail (Size)	NO OF HOLES SIDE A/B	Min. Distance between the opening for Side A/B (mm)	TOP DISTANC EA&B/ C&D	NO OF HOLES SIDE C/D	Min. Distance between the opening for Side C/D (mm)	Opening Detail (Size) PG	NO OF HOLES SIDE A/B	Min. Distance between the opening for Side A/B (mm)	TOP DISTANC EA&B/ C&D	NO OF HOLES SIDE C/D	Min. Distance between the opening for Side C/D (mm)	Min. Distance of last opening from the enclosure end on side A/B (mm)	Min. Distance of last opening from the enclosure end on side C/D (mm)
M12	11	11	-	7	10	Pg.7	11	11	-	7	10	22	36
M16	11	11	-	7	10	Pg.9	11	11	-	7	10	22	36
M20	8	10	-	6	10	Pg.11	11	8	-	6	11	24	39
M25	5	14	-	3	14	Pg.13.5	8	9	-	6	9	22	36
M32	3	18	-	2	20	Pg.16	8	10	-	5	10	20	38
M40	2	30	-	1	-	Pg.21	5	11	-	2	36	25	41
M50	2	20	-	-	-	Pg.29	2	28	-	2	11	20	37
M63	-	-	-	-	-	Pg.36	2	18	-	1	-	23	41
-	-	-	-	-	-	Pg.42	1	-	-	-	-	-	29
-	-	-	-	-	-	Pg.48	-	-	-	-	-	-	-
-	-	-	-	-	-	-	-	-	-	-	-	-	-

PROPERTY OF RaychemRPG (P) LTD.
ALL RIGHTS RESERVED AND/OR PHOTOCOPYING THIS DOCUMENT
TO A PERSON WITHOUT RaychemRPG (P)LTD. WRITTEN AUTHORIZATION IS PROHIBITED

SR.NO.	PART NAME	DRAWING NO.	MATERIAL	QTY
5	SILICON GASKATE	JB-02GSK-13	SILICON	1
4	JB EXTERNAL EARTHING SET	-	AISI 304	1
3	LID MOUNTING SCREW	JB-SCR-LD-00	AISI 304	4
2	JB-EARTHING SCREW	-	MS COPPER PLATED	2
1	JUNCTION BOX Ex-160 X160X91	Ex-16016091	AISI 12	1

B.O.M.

QUANTITY	MATERIAL :-	MACH.NAME	DATE	SIGN	NAME
-	AISI 12 DIN230	-	17/08/14		RRPL DESIGN
WEIGHT:	FINISH:	TITLE :-	17/08/14		MANOJ DRAWN
-	NATURAL	JUNCTION BOX 160 x 160 x 90			G.K. CHECKED
TOLERANCE	ALL DIMENSION ARE IN MM	Raychem RPG (P) Limited	SCALE	PARTNO.	0
±0.2 DIMENSIONS ±0.2 HOLES ±1.0° ANGLES	RJ 15	Ceat Mahal Annexe, Dr. Anile Besant Road , Worli , Mumbai 400030 Web : www.raychemrpg.com	REV	DRG. NO.	0
			0		Ex-AJB-16016090-U